

3 BHK CARPET AREA CHART TYPE-1G

1	1	X	1.600	X	3.080	=	4.93
2	2	X	2.000	X	0.150	=	0.60
3	1	X	7.975	X	6.330	=	50.48
4	1	X	3.170	X	1.200	=	3.80
5	1	X	0.150	X	1.050	=	0.16
NET CARPET AREA = 59.97							
TERRACE AREA CHART TYPE-1G							
A	1	X	9.730	X	2.030	=	19.75
B	1	X	1.600	X	3.330	=	5.33
C	1	X	3.060	X	1.200	=	3.67
NET BALCONY AREA = 28.75							

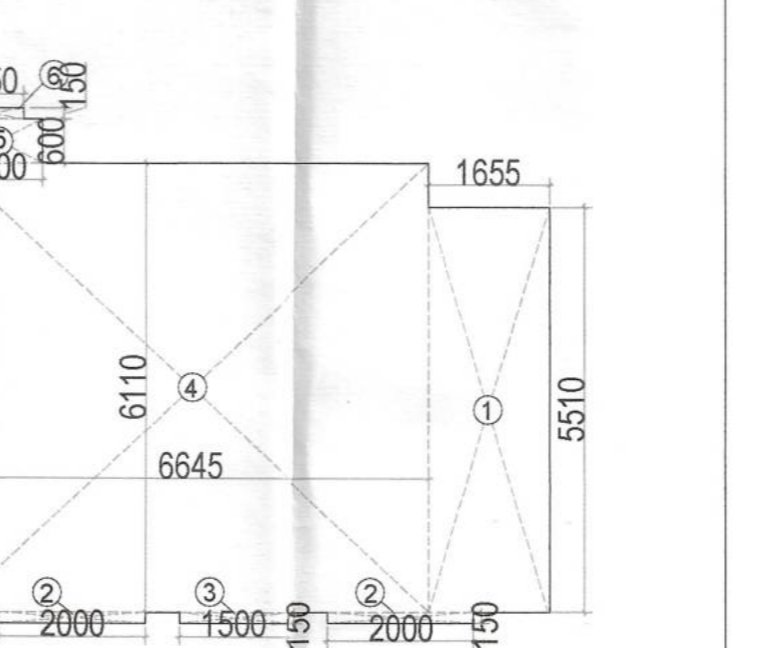

2 BHK - TYPE-3P
CARPET AREA = 51.32 SQMT
BALCONY AREA = 11.43 SQMT

2 BHK CARPET AREA CHART TYPE-3P

1	1	X	1.625	X	5.510	=	8.954
2	2	X	2.000	X	0.150	=	0.600
3	1	X	1.500	X	0.150	=	0.225
4	1	X	6.645	X	6.110	=	40.601
5	1	X	1.300	X	0.600	=	0.780
6	1	X	1.050	X	0.150	=	0.158
NET CARPET AREA = 51.32							
TERRACE AREA CHART TYPE-3P							
A	1	X	8.470	X	1.350	=	11.43
NET BALCONY AREA = 11.43							

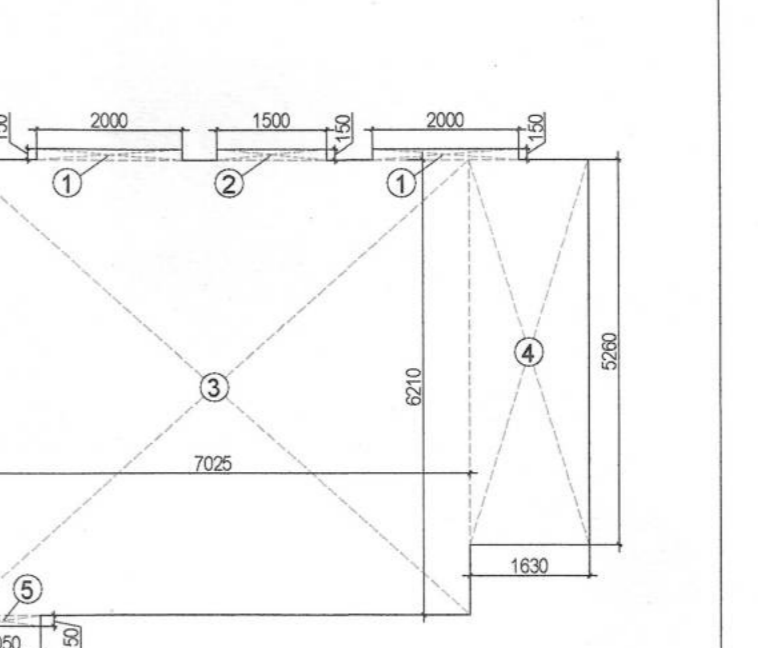
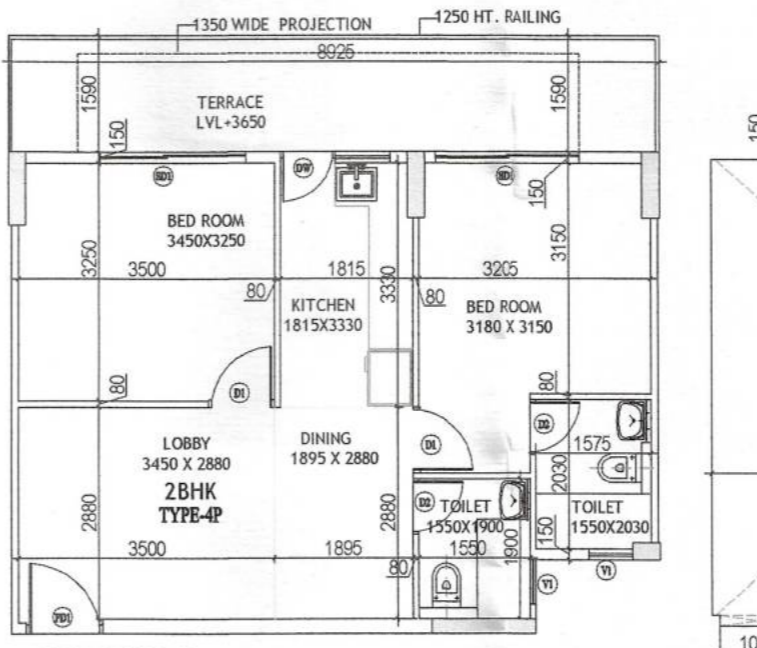

2BHK - TYPE-4P
CARPET AREA = 53.18 SQMT
BALCONY AREA = 14.19 SQMT

2 BHK CARPET AREA CHART TYPE-4P

1	2	X	2.000	X	0.150	=	0.60
2	1	X	1.500	X	0.150	=	0.225
3	1	X	7.025	X	6.210	=	43.63
4	1	X	1.630	X	5.260	=	8.57
5	1	X	1.050	X	0.150	=	0.16
NET CARPET AREA = 53.18							
BALCONY AREA CHART TYPE-4P							
A	1	X	8.925	X	1.590	=	14.19
NET BALCONY AREA = 14.19							

2 BHK CARPET AREA CHART TYPE-5P

1	1	X	1.050	X	3.160	=	3.318
2	1	X	5.060	X	2.960	=	14.978
3	1	X	1.630	X	5.360	=	8.737
4	1	X	7.010	X	3.350	=	23.484
5	2	X	2.000	X	0.150	=	0.600
6	1	X	1.500	X	0.150	=	0.225
NET CARPET AREA = 51.34							
TERRACE AREA CHART TYPE-5P							
A	1	X	1.000	X	3.500	=	3.50
B	1	X	10.160	X	1.350	=	13.72
NET BALCONY AREA = 17.22							

S.T.P. (H) Member Secretary B.P.A.C.
S.T.P. (G) Member B.P.A.C.
C.T.R. (HR) Chairman B.P.A.C.
AD PA ATP

Parveen Kumar SD(HQ)

SANCTIONED TO BE READ WITH THIS OFFICE MEMO NO. DATED :

J.D.T. Member B.P.A.C.

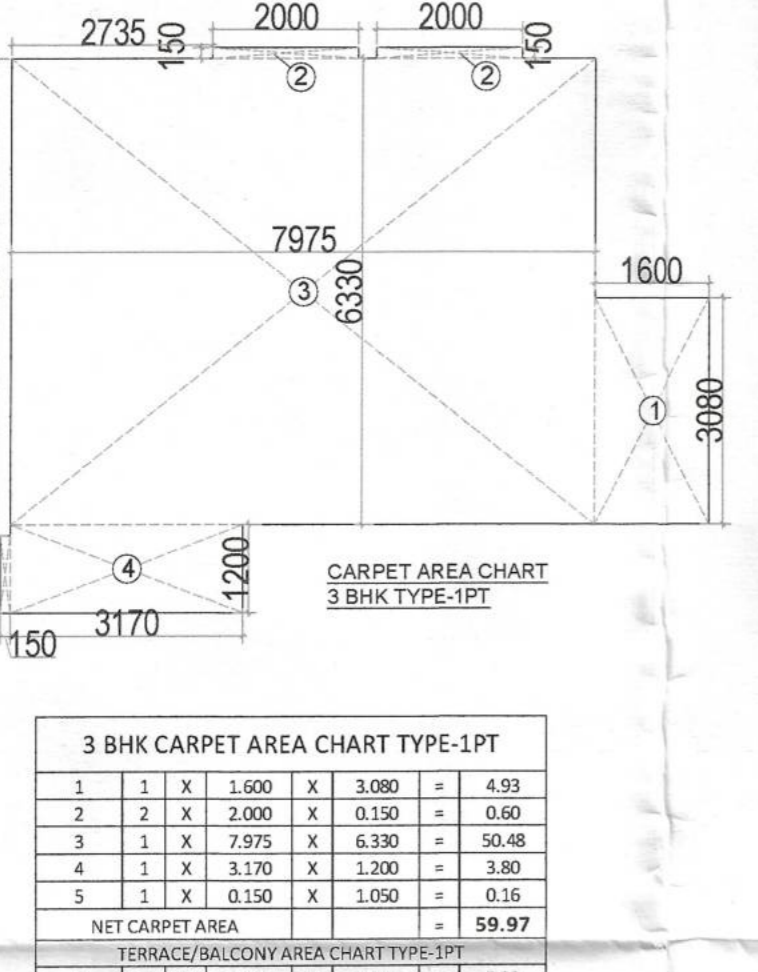
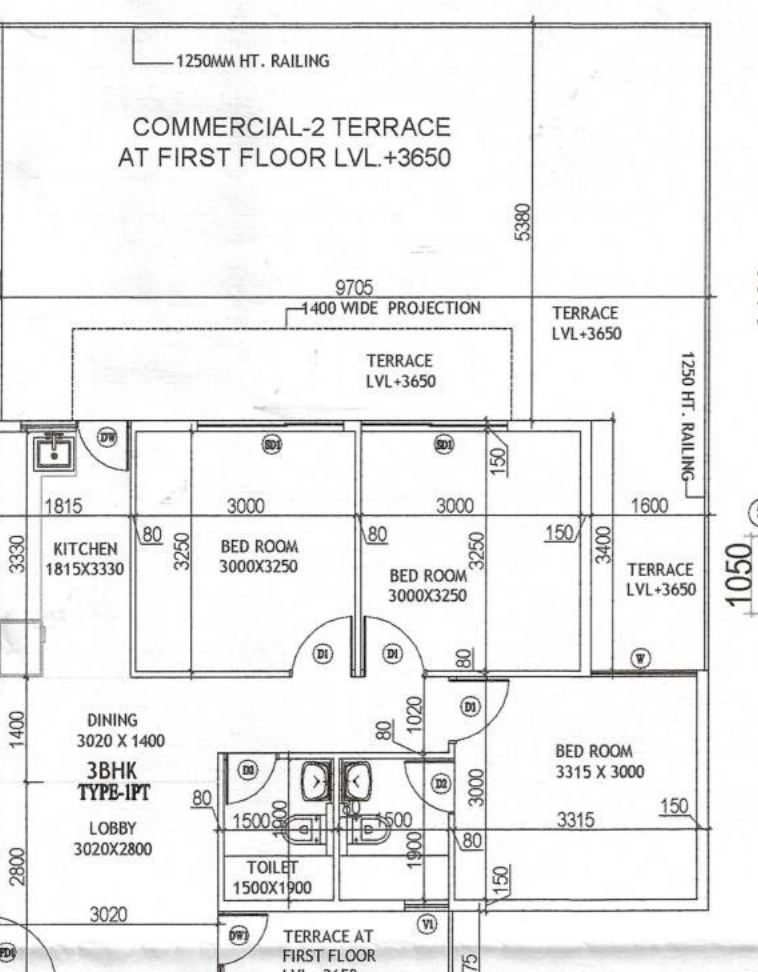

3 BHK - TYPE-1PT
CARPET AREA = 59.97 SQMT
TERRACE AREA = 62.98 SQMT

3 BHK CARPET AREA CHART TYPE-1PT

1	1	X	1.600	X	3.080	=	4.93
2	2	X	2.000	X	0.150	=	0.60
3	1	X	7.975	X	6.330	=	50.48
4	1	X	3.170	X	1.200	=	3.80
5	1	X	0.150	X	1.050	=	0.16
NET CARPET AREA = 59.97							
TERRACE/BALCONY AREA CHART TYPE-1PT							
A	1	X	3.180	X	1.675	=	5.33
B	1	X	1.600	X	3.400	=	5.44
C	1	X	9.705	X	5.380	=	52.21
BALCONY/TERRACE AREA = 62.98							

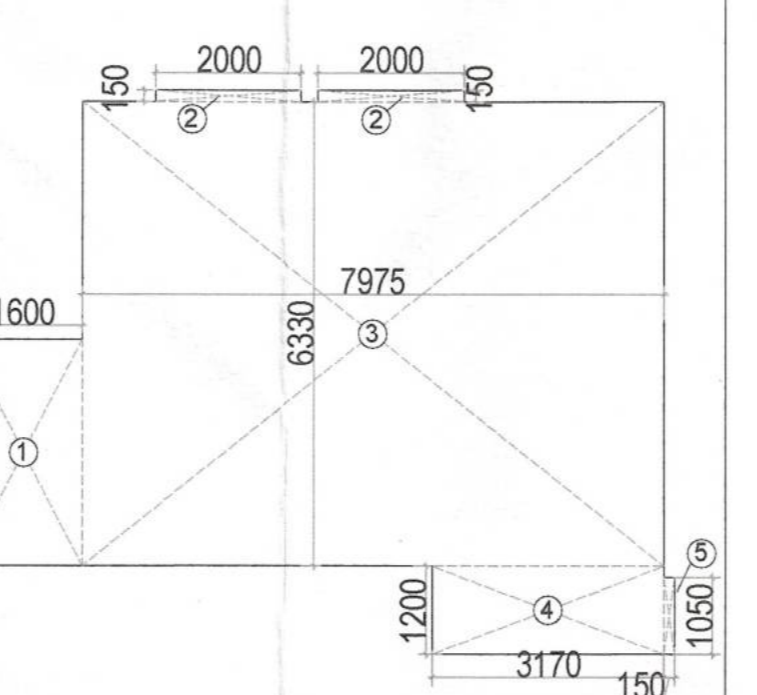
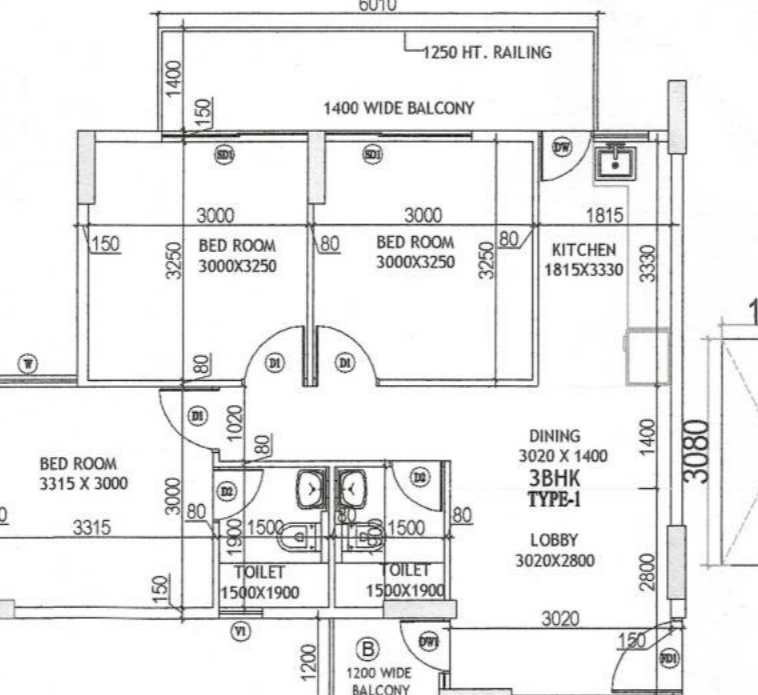

3BHK - TYPE-1
CARPET AREA = 59.97 SQMT
BALCONY AREA = 10.21 SQMT

3 BHK CARPET AREA CHART TYPE-1

1	1	X	1.600	X	3.080	=	4.93
2	2	X	2.000	X	0.150	=	0.60
3	1	X	7.975	X	6.330	=	50.48
4	1	X	3.170	X	1.200	=	3.80
5	1	X	0.150	X	1.050	=	0.16
NET CARPET AREA = 59.97							
BALCONY AREA CHART TYPE-1							
A	1	X	6.010	X	1.400	=	8.41
B	1	X	1.500	X	1.200	=	1.80
NET BALCONY AREA = 10.21							

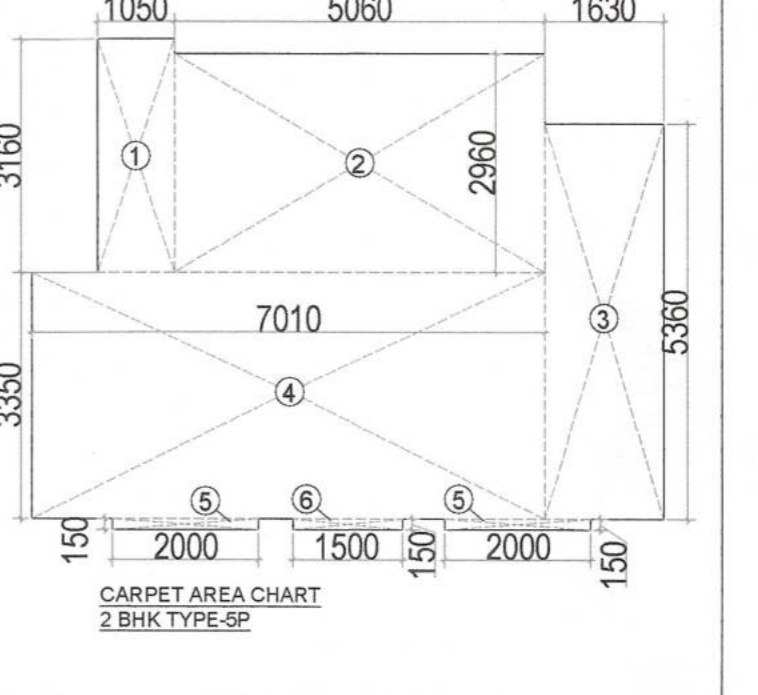

2BHK - TYPE-5P
CARPET AREA = 51.34 SQMT
BALCONY AREA = 17.22 SQMT

2 BHK CARPET AREA CHART TYPE-5P

1	2	X	2.000	X	0.150	=	0.60
2	1	X	1.500	X	0.150	=	0.225
3	1	X	7.025	X	6.210	=	43.63
4	1	X	1.630	X	5.260	=	8.57
5	1	X	1.050	X	0.150	=	0.16
NET CARPET AREA = 53.18							
BALCONY AREA CHART TYPE-4							
A	1	X	6.900	X	1.350	=	9.32
NET BALCONY AREA = 9.32							

2 BHK CARPET AREA CHART TYPE-4

1	2	X	2.000	X	0.150	=	0.60
2	1	X	1.500	X	0.150	=	0.225
3	1	X	7.025	X	6.210	=	43.63
4	1	X	1.630	X	5.260	=	8.57
5	1	X	1.050	X	0.150	=	0.16
NET CARPET AREA = 53.18							
BALCONY AREA CHART TYPE-4							
A	1	X	6.900	X	1.350	=	9.32
NET BALCONY AREA = 9.32							

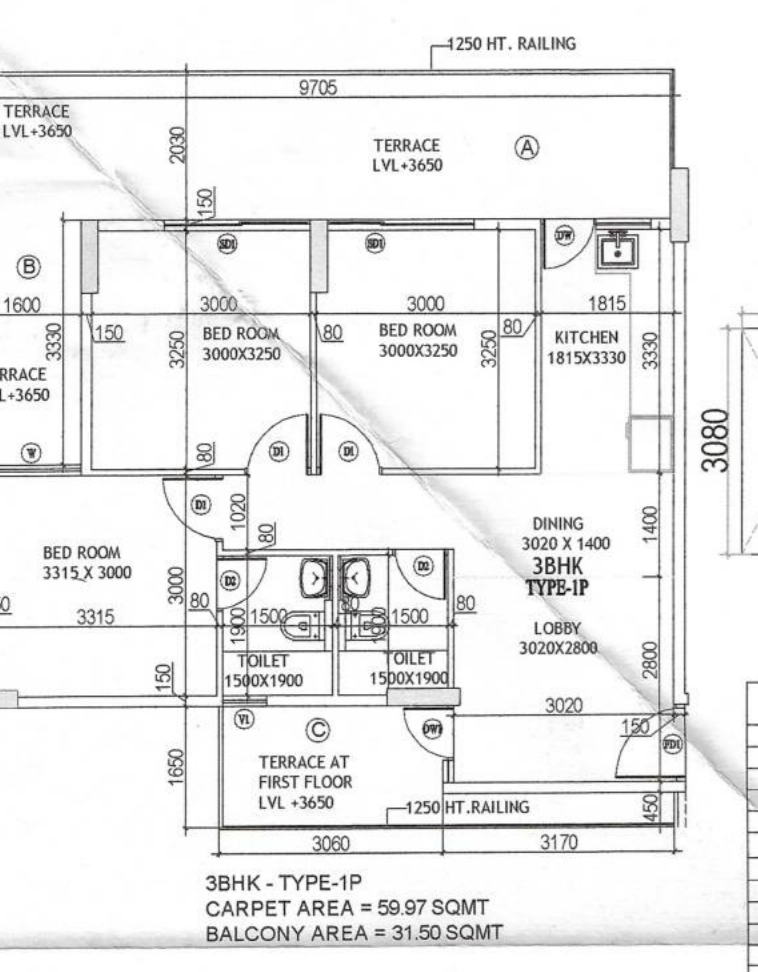

3 BHK - TYPE-1P
CARPET AREA = 59.97 SQMT
BALCONY AREA = 31.50 SQMT

3 BHK CARPET AREA CHART TYPE-1P

1	1	X	1.600	X	3.080	=	4.93
2	2	X	2.000	X	0.150	=	0.60
3	1	X	7.975	X	6.330	=	50.48
4	1	X	3.170	X	1.200	=	3.80
5	1	X	0.150	X	1.050	=	0.16
NET CARPET AREA = 59.97							
TERRACE AREA CHART TYPE-1P							
A	1	X	9.705	X	1.205	=	11.70
B	1	X	1.600	X	3.330	=	5.33
C	1	X	6.900	X	1.350	=	9.32
D	1	X	3.170	X	0.450	=	1.43
NET BALCONY AREA = 31.50							

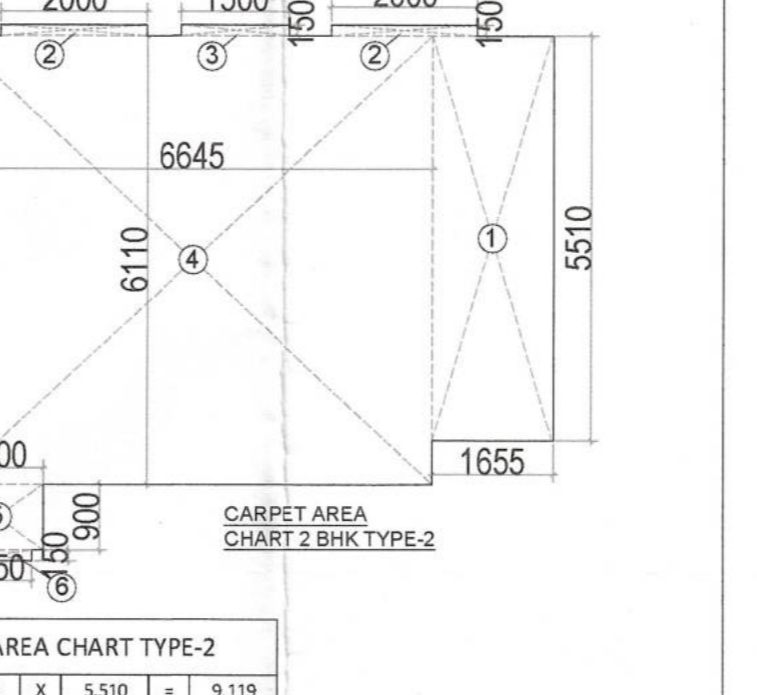

2BHK - TYPE-2
CARPET AREA = 51.87 SQMT
BALCONY AREA = 9.32 SQMT

2 BHK CARPET AREA CHART TYPE-2

1	1	X	1.655	X	5.510	=	9.119
2	2	X	2.000	X	0.150	=	0.600
3	1	X	1.500	X	0.150	=	0.225
4	1	X	6.645	X	6.110	=	40.601
5	1	X	1.300	X	0.900	=	1.170
6	1	X	1.050	X	0.150	=	0.158
NET CARPET AREA = 51.87							
BALCONY AREA CHART TYPE-2							
A	1	X	6.900	X	1.350	=	9.32
NET BALCONY AREA = 9.32							

2 BHK CARPET AREA CHART TYPE-2

1	1	X	1.655	X	5.510	=	9.119
2	2	X	2.000	X	0.150	=	0.600
3	1	X	1.500	X	0.150	=	0.225
4	1	X	6.645	X	6.110	=	40.601
5	1	X	1.300	X	0.900	=	1.170
6	1	X	1.050	X	0.150	=	0.158
NET CARPET AREA = 51.87							
BALCONY AREA CHART TYPE-2							
A	1	X	6.900	X	1.350	=	9.32
NET BALCONY AREA = 9.32							

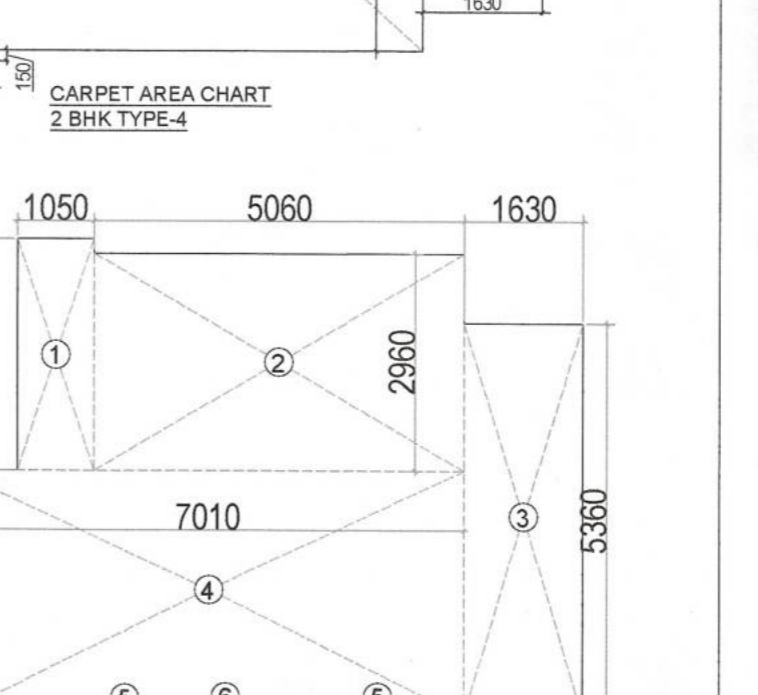
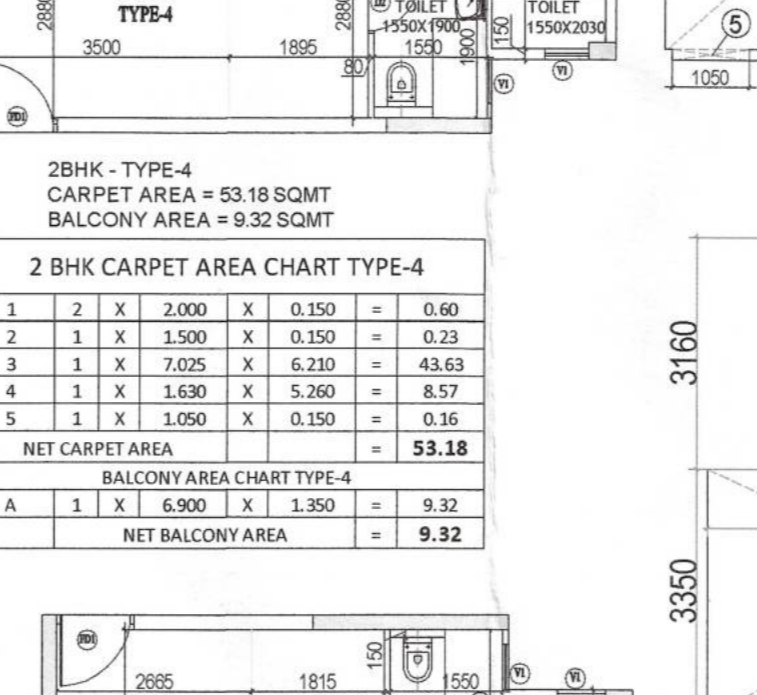

2BHK - TYPE-4
CARPET AREA = 53.18 SQMT
BALCONY AREA = 9.32 SQMT

2 BHK CARPET AREA CHART TYPE-4

1	2	X	2.000	X	0.150	=	0.60
2	1	X	1.500	X	0.150	=	0.225
3	1	X	7.025	X	6.210	=	43.63
4	1	X	1.630	X	5.260	=	8.57
5	1	X	1.050	X	0.150	=	0.16
NET CARPET AREA = 53.18							
BALCONY AREA CHART TYPE-4							
A	1	X	6.900	X	1.350	=	9.32
NET BALCONY AREA = 9.32							

2 BHK CARPET AREA CHART TYPE-4

1	2	X	2.000	X	0.150	=	0.60
2	1	X	1.500	X	0.150	=	0.225
3	1	X	7.025	X	6.210	=	43.63
4	1	X	1.630	X	5.260	=	8.57
5	1	X	1.050	X	0.150	=	0.16
NET CARPET AREA = 53.18							
BALCONY AREA CHART TYPE-4							
A	1	X	6.900	X	1.350	=	9.32
NET BALCONY AREA = 9.32							

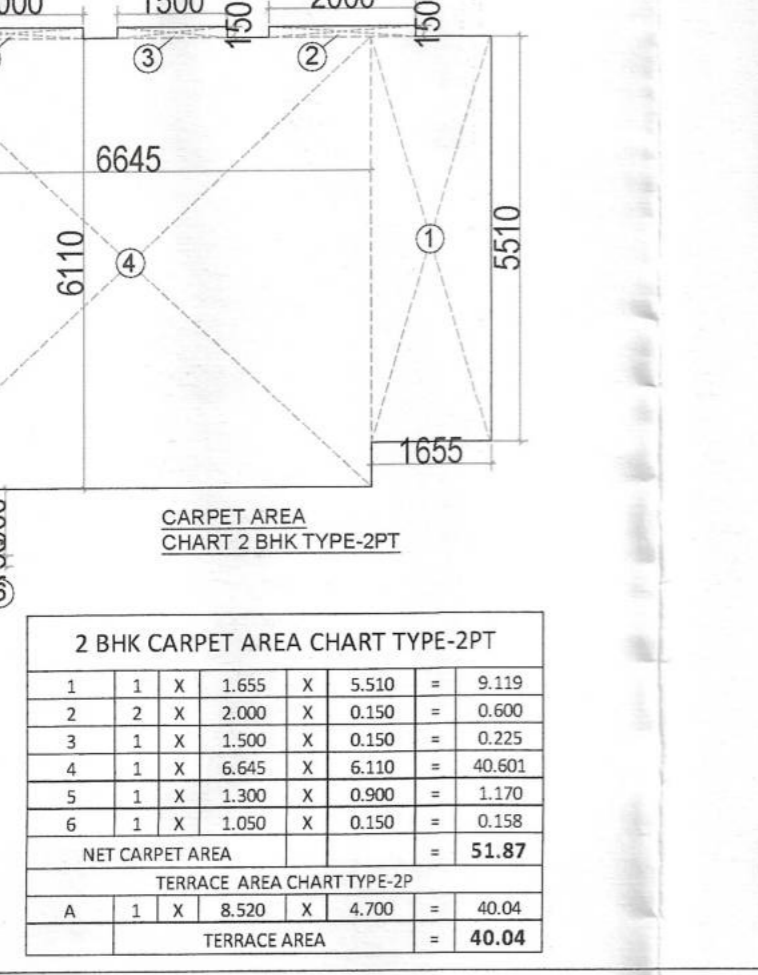
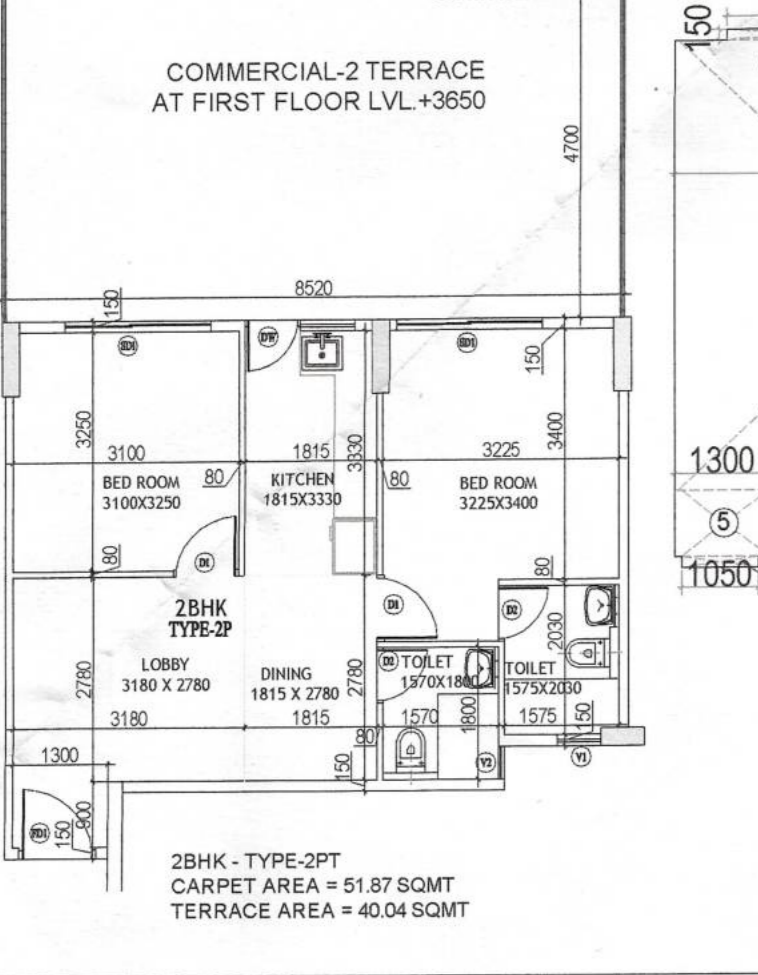

2BHK - TYPE-2PT
CARPET AREA = 51.87 SQMT
TERRACE AREA = 40.04 SQMT

2 BHK CARPET AREA CHART TYPE-2PT

1	1	X	1.655	X	5.510	=	9.119
2	2	X	2.000	X	0.150	=	0.600
3	1	X	1.500	X	0.150	=	0.225
4	1	X	6.645	X	6.110	=	40.601
5	1	X	1.300	X	0.900	=	1.170
6	1	X	1.050	X	0.150	=	0.158
NET CARPET AREA = 51.87							
TERRACE AREA CHART TYPE-2PT							
A	1	X	8.520	X	4.700	=	40.04
TERRACE AREA = 40.04							

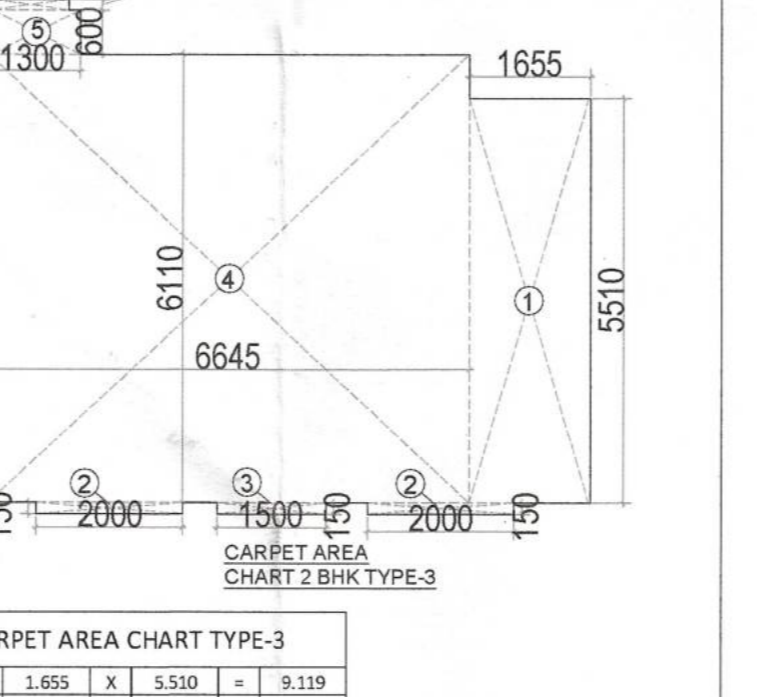

2BHK - TYPE-3
CARPET AREA = 51.01 SQMT
BALCONY AREA = 9.32 SQMT

2 BHK CARPET AREA CHART TYPE-3

1	1	X	1.655	X	5.510	=	9.119
2	2	X	2.000	X	0.150	=	0.600
3	1	X	1.500	X	0.150	=	0.225
4	1	X	6.645	X	6.110	=	40.601
5	1	X	1.300	X	0.600	=	0.780
6	1	X	1.050	X	0.150	=	0.158
NET CARPET AREA = 51.48							
BALCONY AREA CHART TYPE-3							
A	1	X	6.900	X	1.350	=	9.32
NET BALCONY AREA = 9.32							

2 BHK CARPET AREA CHART TYPE-3

1	1	X	1.655	X	5.510	=	9.119
2	2	X	2.000	X	0.150	=	0.600
3	1	X	1.500	X	0.150	=	0.225
4	1	X	6.645	X	6.110	=	40.601
5	1	X	1.300	X	0.600	=	0.780
6	1	X	1.050	X	0.150	=	0.158
NET CARPET AREA = 51.48							
BALCONY AREA CHART TYPE-3							
A	1	X	6.900	X	1.350	=	9.32
NET BALCONY AREA = 9.32							

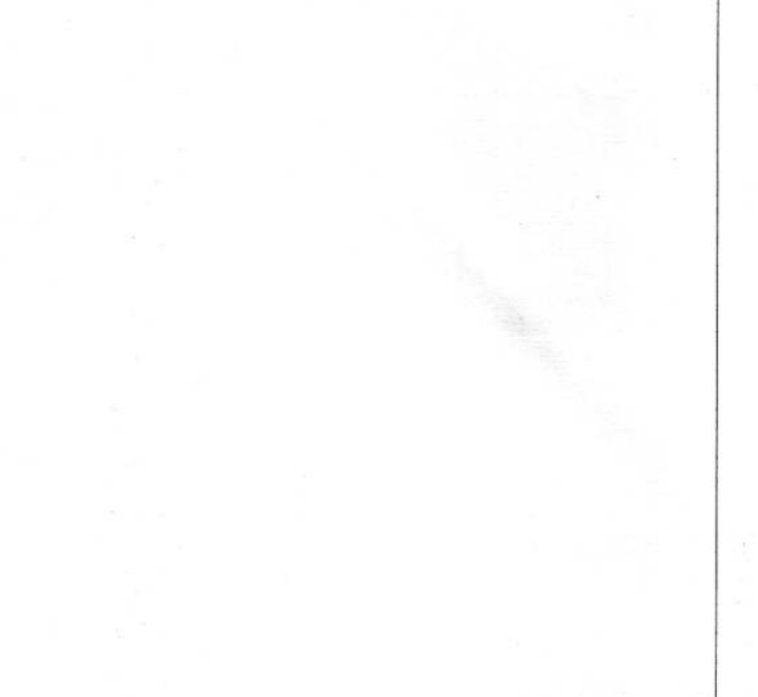
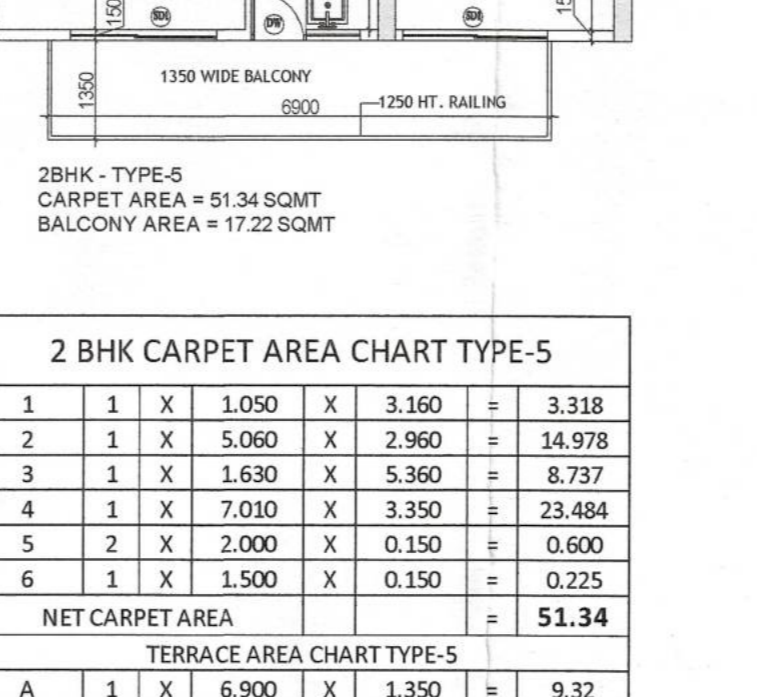

2 BHK - TYPE-5
CARPET AREA = 51.34 SQMT
BALCONY AREA = 17.22 SQMT

2 BHK CARPET AREA CHART TYPE-5

1	1	X	1.050	X	3.160	=	3.318
2	1	X	5.060	X	2.960	=	14.978
3	1	X	1.630	X	5.360	=	8.737
4	1	X	7.010	X	3.350	=	23.484
5	2	X	2.000	X	0.150	=	0.600
6	1	X	1.500	X	0.150	=	0.225
NET CARPET AREA = 51.34							
TERRACE AREA CHART TYPE-5							
A	1	X	6.900	X	1.350		